

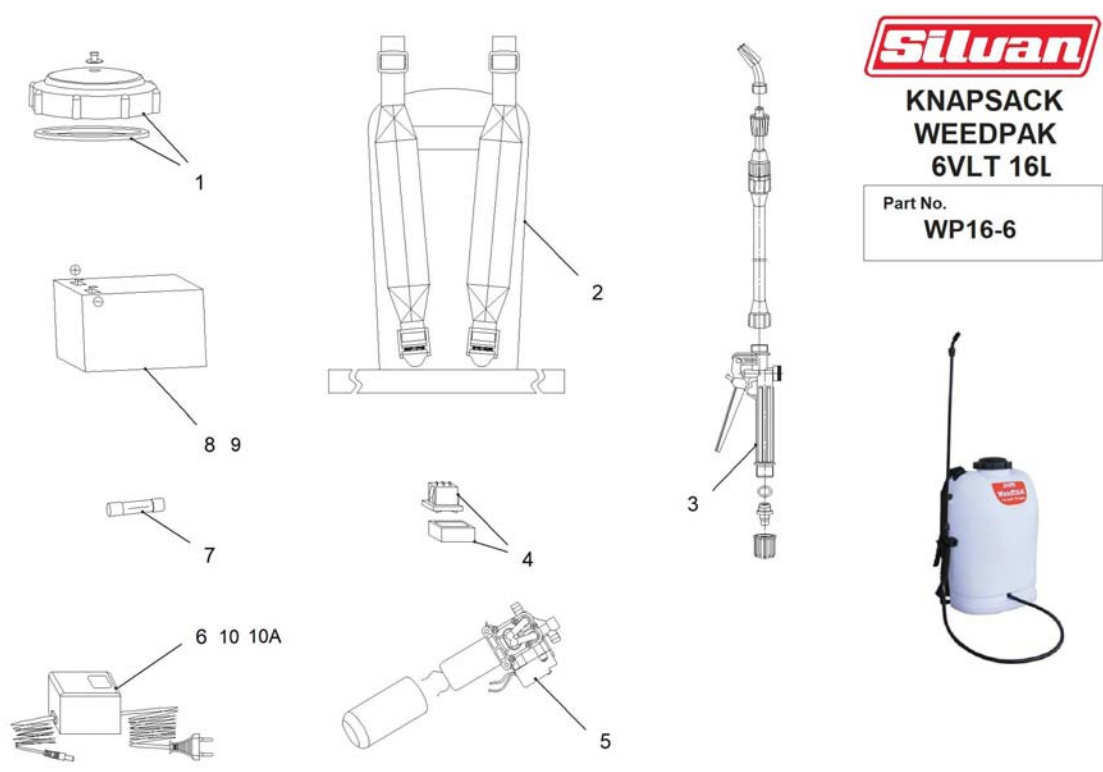







WP16-6



Silvan
KNAPSACK WEEDPAK 6VLT 16L
 Part No. **WP16-6**



		Code	Description	Qty Note	EAN CODE
1		382-001	LID SUIT 20L WEEDPAK	1,00	9327602176799
2		382-040	HARNESS SUIT WP16-1 WP16-6 KNAPSACK	1,00	9337027030255
3		382-010	LANCE SUIT KN15-1 & WP16-1	1,00	9327602211865
4		118-149	ROCKER SWITCH	1,00	9327602029408
5		382-072	PUMP 6V SUIT WP16-6	1,00	9327602310759

6		382-062	BAT CHARGER FOR WP16-6 6V KNAPSACK	1,00 TO MAY 2016	9337027048229
7		118-092	FUSE M205 15AMP (PACK OF 5)	1,00	9327602042438
8		BAT4	BATTERY 6AH 6V	1,00 TO MAY 2016	9327602310988
9		BAT6	BATTERY 7.4V LI ION SUIT WP16-6	1,00 TO MAY 2016	9327602323650
10		382-075	BAT CHARGER ROUND PLUG 7.2V LITHIUM WP16-6	1,00 FROM MAY 2016	9327602316683
10A		382-075B	BAT CHARGER SQUARE PLUG 2PIN WP16-6 LITHIUM	1,00 CHARGING SOCKET (NEW)	9327602325753